

MClimate T-Valve LoRaWAN®

User manual

Scan the QR Code to access MClimate T-Valve LoRaWAN® extended documentation



Bulgarian

За да разберете как се инсталира MClimate T-Valve LoRaWAN®, сканирайте QR кода или посетете линка до него.

Czech

Chcete-li zjistit, jak nainstalovat MClimate T-Valve LoRaWAN®, prohlédněte si kód QR nebo navštivte odkaz vedle něj.

Italian

Per installare MClimate T-Valve LoRaWAN® scannerizzare il codice QR oppure aprire il link al suo lato.

Swedish

För att ta reda på hur du installerar MClimate T-Valve LoRaWAN®, skanna QR-koden eller besök länken bredvid den.

Spanish

Para saber cómo instalar MClimate T-Valve LoRaWAN®, escanee el código QR o visite el enlace al lado.

Dutch

Om te weten te komen hoe u MClimate T-Valve LoRaWAN® installeert, scan de QR-code of bezoek de link ernaast.

Finnish

Tutustu MClimate T-Valve LoRaWAN®-laitteen asentamiseen, skanna QR-koodi tai vierailla sen vieressä olevassa linkissä.

Polish

Aby dowiedzieć się, jak zainstalować MClimate T-Valve LoRaWAN®, zeskanuj kod QR lub odwiedź link obok niego.

German

Um herauszufinden, wie man MClimate T-Valve LoRaWAN® installiert, scannen Sie den QR-Code oder besuchen Sie den Link daneben.

French

Pour savoir comment installer MClimate T-Valve LoRaWAN®, scannez le code QR ou visitez le lien à côté de celui-ci.

Need some help?

For more product information and issues related to it, visit:
mclimate.eu/lorawan-resources

or write us to:
lorawan-support@mclimate.eu



00359 800 3 1010

Monday-Friday 09:00 - 18:00



Sofia, Bulgaria

Sofia Tech Park, Labs Building, 111J Tsarigradsko Shose

Table of content

01	What is in the box?	2
02	Technical details, Safety instructions, Legal Notices & Compatibility	3
03	Device Parts, Mechanical dimensions	4-5
04	Commissioning	6-8
05	LEDs and behaviour	9-10
06	Optional installation of external accessories	
	a. Installing a wired flood sensor	
	b. Installing an external power supply	
		11-14

What's inside the box?

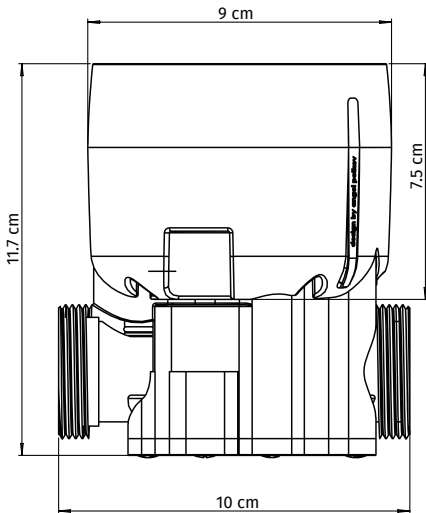

MClimate T-Valve LoRaWAN®

Technical specifications

Description: T-Valve is a smart LoRaWAN® water valve used in residential or commercial buildings. DN20 and DN32 versions available, certified for Drinking Water. It has 10 years of battery life calculated with daily on/off's. It also measures water and environment temperature. It has multiple tamper protection mechanisms - tracking magnetic interference and if the device is being physically abused. Optionally a wired flood sensor and external power supply can be installed. T-Valve gives you the opportunity to stop potential water damage from happening, by being able to control the main water supply in your property from a distance. No more floods and damages.

Model: MC-LW-T-VALVE-01

Dimensions: 105 x 117 x 90.8mm

Weight: 600gr

Frequency range: 863-870MHz

LoRaWAN® Device type: Class A End-device

Power supply: built-in battery: LiSOC12 ER26500 3.6V 9000mAh

External power supply: 5-9VDC

Sensors: 1xWater Temperature Sensor, 1xAmbient Temperature sensor, 1xMagnetic field sensor, 1xWired flood sensor (optional)

Work temperature: 0°C to +60°C

Media Temperature: 1°C to 75 °C

IP protection: IP68

Material: PC/ABS; Valve PPE/PS

Environmental conditions, in which the device is intended to operate:

- Indoor using;
- for altitude up to 2000m;
- for an ambient temperature: 0°C to +60°C;
- for maximum relative humidity of 80% for temperature up to 31°C, decreasing linearly to 25% relative humidity at temperature 50°C;
- for environment with a degree of contamination 2 (PD2).

Storage and transportation conditions:

- for an ambient temperature: -40°C to +85°C;
- for relative humidity 5% to 90% without condensation

Manufacturer

MClimate Jsc

1784 Sofia, Sofia Tech Park, Labs Building, 111) Tsarigradsko Shose

Compliance with the WEEE Directive

The appliance marked with this symbol should not be disposed of with other household waste. It must be handed over to the relevant collection point for the recycling of electrical and electronic equipment.

Safety Instructions

Please read the safety instructions before installing the device! Failure to follow the recommended instructions in this manual may be dangerous or in violation of the law. The manufacturer MClimate Jsc., is not responsible for any loss or damage caused by failure to follow the instructions in the operating manual.

Legal Notices

All information, including but not limited to, features, functionality, and / or other product specifications are subject to change without notice. MClimate retains all rights to review or update its products, software or documentation without being required to notify any natural or legal person.

The MClimate and MClimate logo are trademarks of MClimate Jsc. All other brands and product names mentioned herein are trademarks of their respective owners.

EU Declaration of Conformity

This device complies with the essential requirements and other applicable provisions of the following EU directives:

2014/53/EC

EN 50491-3:2009

EEU 300 220-1 V3.1.1:2017

EEU 300 220-2 V3.1.1:2017

EN 60950-1:2006+A11:2009 +A1:2010+A12:2011+

A2:2013 + AC:2015

EN 301 489-1 V2.1.1:2017

Drinking water certification:

ACS, KTW, NSF/ANSI/CAN (61-2018), NSF/ANSI (372-2016), USA California Health and Safety Code 11687, USA S.3874 - 111th Congress (2009-2010)

Compatibility

In order to operate MClimate T-Valve

LoRaWAN®, you will need:

LoRaWAN® network



Device parts

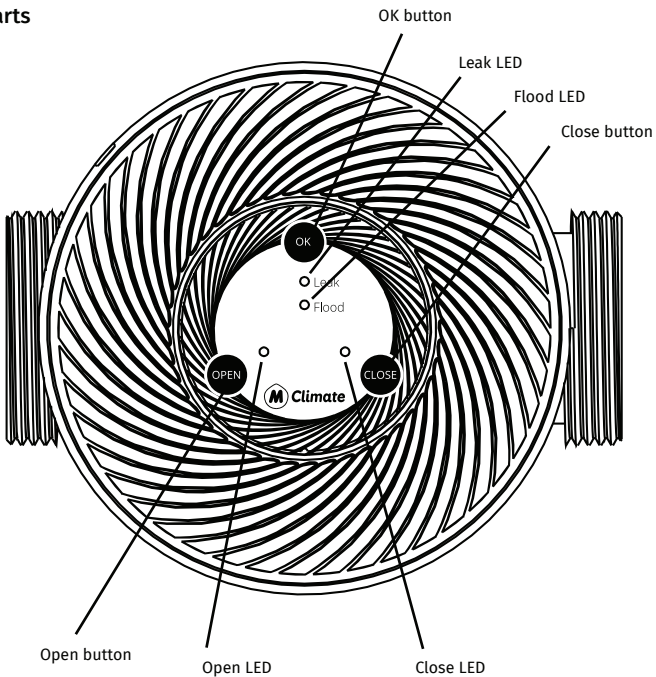

Device, top view

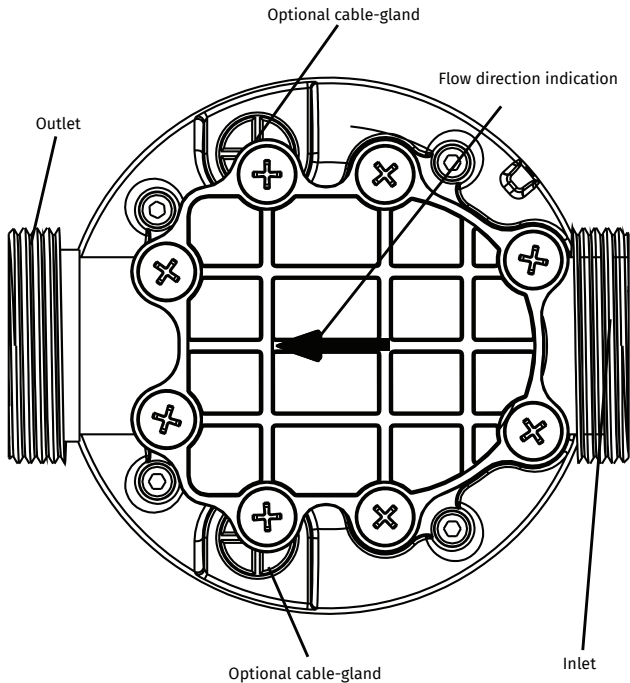

Device, bottom view

Commissioning



Before you install the device, we highly recommend that you first commission it on your LNS. Once the device is activated it will initiate a LoRaWAN Join Procedure on SF12. Please, make sure you enable ADR in your LNS and/or mark the device as static. The lower the spreading factor, the better the performance of the energy storage will be.

- 1 Open your LoRaWAN® Network provider access panel and add the device using the supplied Serial Number, DevEUI, AppEUI (JoinEUI) and AppKey.

Device ID: 9X7 XXXXXXXXXX

DevEUI: 70B3D25D XXXXXXXXXX

AppEUI: 70B3D25 XXXXXXXXXX

AppKey: A0658DFAE7213 XXXXXXXXXX

Register



The data is example. Do not use.

- 2 Continue the Installation with the instructions of your LoRaWAN® Network provider.

MClimate_LoRaWAN_51177

Serial Number	DevEui	AppEui	AppKey
XXXXXXXXXXXX	70B3D25DXXXXXXXX	70B3D25XXXXXXXXX	563XXXXXXXXXXXXX



You can get DevEUI, AppEUI (JoinEUI) & AppKey information from the LoRaWAN® credentials .csv file we sent you with the fulfillment confirmation.

Commissioning

3 Out of the factory, T-Valve comes in deep-sleep mode and it has to be initially activated in order to start normal operation. In deep-sleep mode the device is not transmitting or receiving any data in order to preserve the battery before being installed. In order to activate T-Valve, press the OK button 5 times quickly. Once it's activated, you will see an alternating animation of the Flood, Leak, CLOSE & OPEN LEDs will be shown.

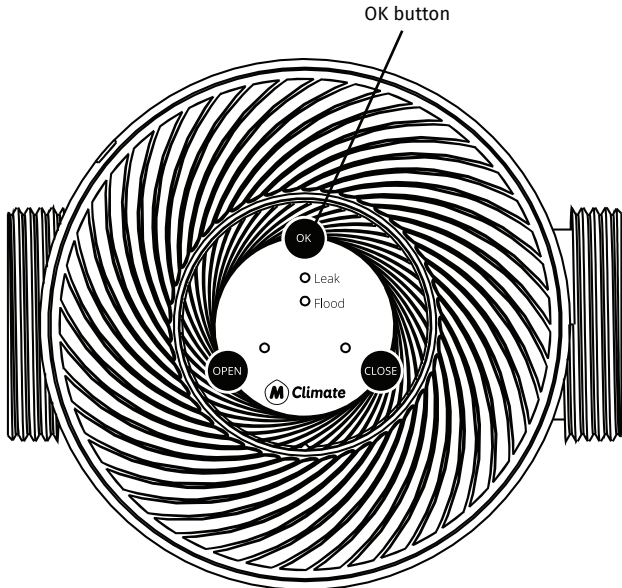

Commissioning

- 4 If T-Valve is NOT connected to a network, when one presses the OK button, an alternating animation of the Flood, Leak, CLOSE & OPEN LEDs will be shown. Once the device has received Join Accept from the LoRaWAN® Network, it will not show the above-described animation. Instead, if one presses the OK button, the LED of the corresponding valve state will be activated shortly - e.g. OPEN LED or CLOSE LED.

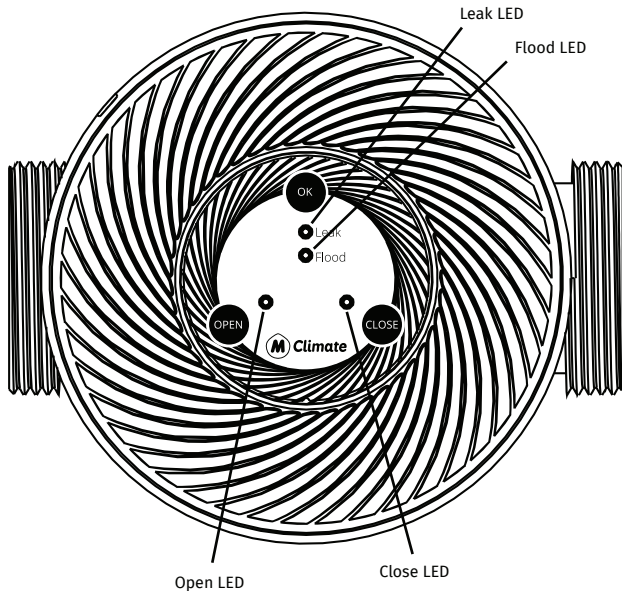

LEDs and behaviour

On the side, you can see an illustration of T-Valve's LEDs and buttons. The LEDs have the following purpose:

#	Name	Purpose
1	OPEN	Activates when one presses the OPEN button or the OK button and the valve is currently open.
2	CLOSE	Activates when one presses the CLOSE button or the OK button and the valve is currently closed.
3	Leak	Activated through a downlink command indicating the customer there's a small leakage detected in the system. T-Valve DOES NOT detect small leakages itself.
4	Flood	Activated in case a wired flood sensor is installed and a flood is detected.



Warning: Opening and closing the valve uses a lot of current. If you press the buttons OPEN and CLOSE fast consecutively, T-Valve may indicate that there's not enough to perform the desired action. Inside, a large capacitor is charged, which takes approx 1s to recharge. If you try to OPEN or CLOSE the T-Valve and this capacitor is not yet fully charged, the OPEN or CLOSE LED will blink 3 times.

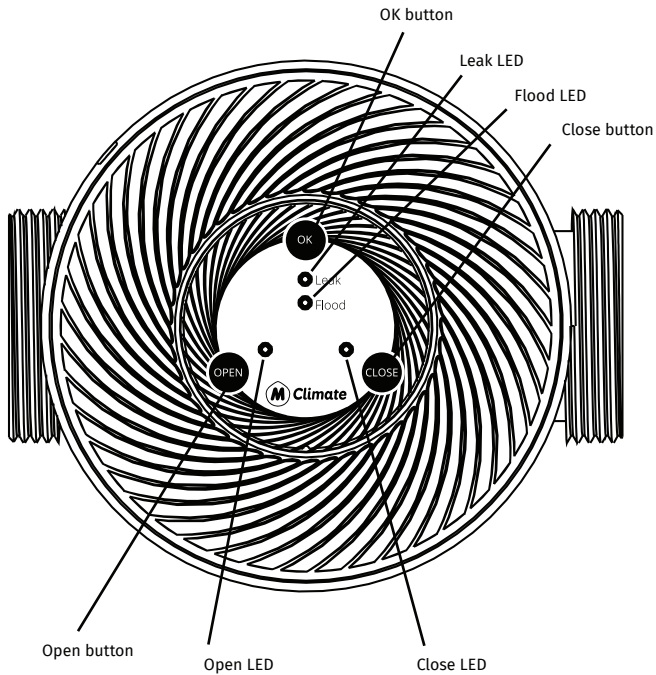

Optional installation of external accessories

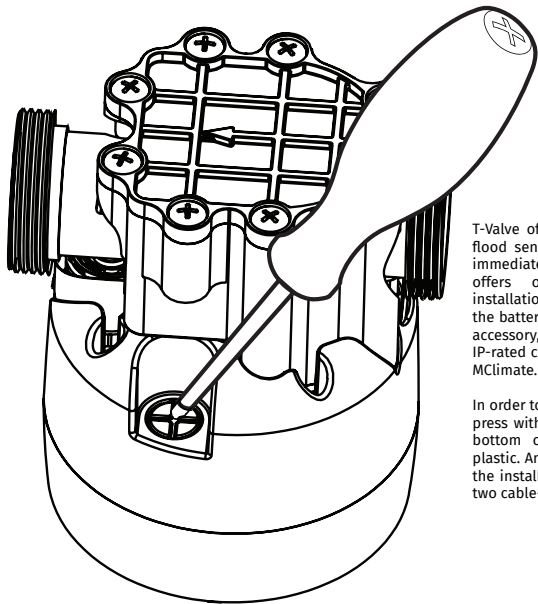

T-Valve offers optional installation of a wired flood sensor and can close the water supply immediately after sensing a flood. T-Valve also offers optional external power supply installation. The power supply DOES NOT charge the battery inside T-Valve. In order to install an accessory, you will need an appropriately IP-rated cable-gland, which can be supplied by MClimate.

In order to install a cable-gland, one has to first press with a screw-driver the openings on the bottom of T-Valve and remove the excess plastic. Any of the two cut-hole can be used for the installation of the cable-gland. If required, two cable-glands can be used.

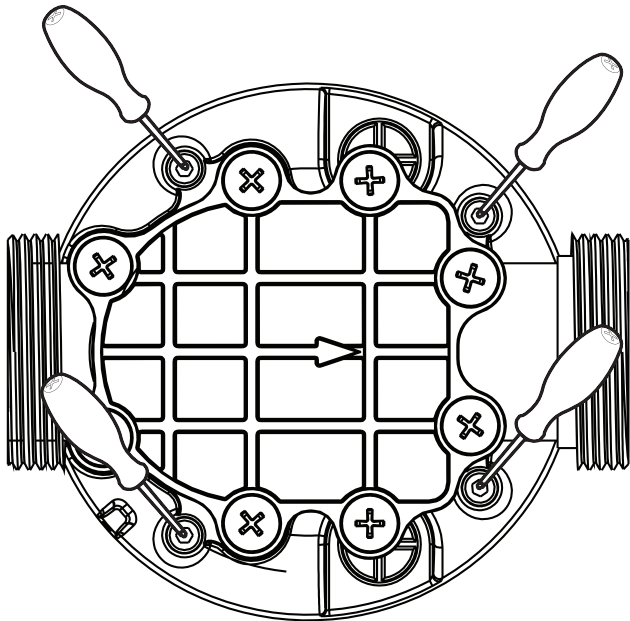

In order to install the cable-gland, one must disassemble the device using the four Phillips screws. If the device is connected to a network, the anti-tamper protection will be activated and the device will signal in the uplink that the device is opened.

Optional installation of external accessories

a. Installation of a wired flood sensor

The wired flood sensor can detect whether a cable is broken or cut. Feed the connector through the cable-gland and install it on T-Valve PCB as described in the picture below.

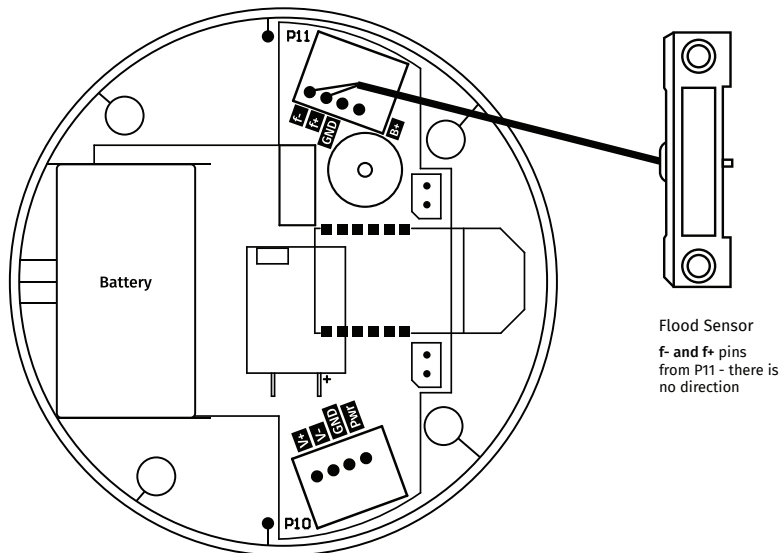

Optional installation of external accessories

a. Installation of external power supply

The external power supply is also fed through a cable-gland and installed on the T-Valve PCB according to the picture below.

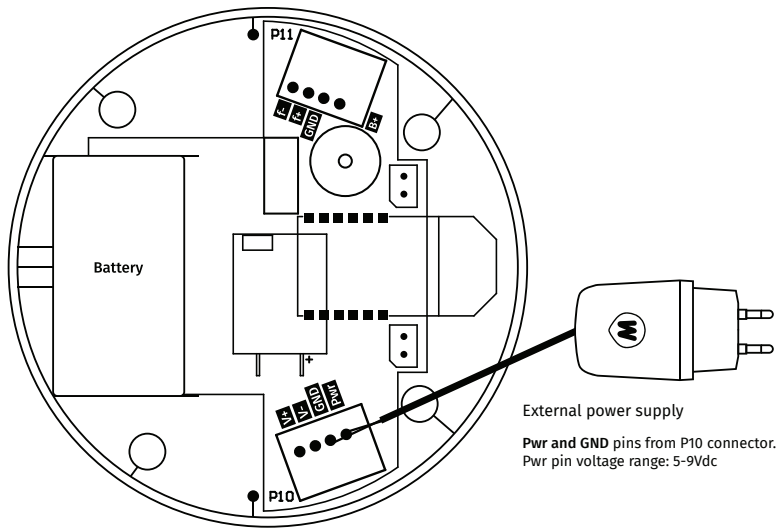

External power supply

Pwr and **GND** pins from P10 connector.
Pwr pin voltage range: 5-9Vdc



www.mclimate.eu

Designed & Manufactured by MClimate in Europe.

last update: 10.07.2024